

NPN Silicon AF Transistors

BC 817
BC 818

- For general AF applications
- High collector current
- High current gain
- Low collector-emitter saturation voltage
- Complementary types: BC 807, BC 808 (PNP)



Type	Marking	Ordering Code	Pin Configuration			Package ¹⁾
			1	2	3	
BC 817-16	6As	Q62702-C1732	B	E	C	SOT-23
BC 817-25	6Bs	Q62702-C1690				
BC 817-40	6Cs	Q62702-C1738				
BC 818-16	6Es	Q62702-C1739				
BC 818-25	6Fs	Q62702-C1740				
BC 818-40	6Gs	Q62702-C1505				

¹⁾ For detailed information see chapter Package Outlines.

Maximum Ratings

Parameter	Symbol	Values		Unit
		BC 817	BC 818	
Collector-emitter voltage	V_{CE0}	45	25	V
Collector-base voltage	V_{CB0}	50	30	
Emitter-base voltage	V_{EB0}	5	5	
Collector current	I_C	500		mA
Peak collector current	I_{CM}	1		A
Base current	I_B	100		mA
Peak base current	I_{BM}	200		
Total power dissipation, $T_C = 79\text{ °C}$	P_{tot}	330		mW
Junction temperature	T_j	150		°C
Storage temperature range	T_{stg}	- 65 ... + 150		

Thermal Resistance

Junction - ambient ¹⁾	$R_{th JA}$	≤ 285	K/W
Junction - soldering point	$R_{th JS}$	≤ 215	

¹⁾ Package mounted on epoxy pcb 40 mm × 40 mm × 1.5 mm/6 cm² Cu.

Electrical Characteristics

at $T_A = 25\text{ °C}$, unless otherwise specified.

Parameter	Symbol	Values			Unit
		min.	typ.	max.	

DC characteristics

Collector-emitter breakdown voltage $I_C = 10\text{ mA}$	$V_{(BR)CE0}$				V
BC 817		45	–	–	
BC 818		25	–	–	
Collector-base breakdown voltage $I_C = 100\text{ }\mu\text{A}$	$V_{(BR)CB0}$				
BC 817		50	–	–	
BC 818		30	–	–	
Emitter-base breakdown voltage, $I_E = 10\text{ }\mu\text{A}$	$V_{(BR)EB0}$	5	–	–	
Collector cutoff current $V_{CB} = 25\text{ V}$ $V_{CB} = 25\text{ V}, T_A = 150\text{ °C}$	I_{CB0}	–	–	100	nA
		–	–	50	μA
Emitter cutoff current, $V_{EB} = 4\text{ V}$	I_{EB0}	–	–	100	nA
DC current gain ¹⁾ $I_C = 100\text{ mA}; V_{CE} = 1\text{ V}$	h_{FE}				–
BC 817-16, BC 818-16		100	160	250	
BC 817-25, BC 818-25		160	250	400	
BC 817-40, BC 818-40		250	350	630	
$I_C = 300\text{ mA}; V_{CE} = 1\text{ V}$					
BC 817-16, BC 818-16		60	–	–	
BC 817-25, BC 818-25		100	–	–	
BC 817-40, BC 818-40		170	–	–	
Collector-emitter saturation voltage ¹⁾ $I_C = 500\text{ mA}; I_B = 50\text{ mA}$	V_{CEsat}	–	–	0.7	V
Base-emitter saturation voltage ¹⁾ $I_C = 500\text{ mA}; I_B = 50\text{ mA}$	V_{BEsat}	–	–	2	

AC characteristics

Transition frequency $I_C = 50\text{ mA}, V_{CE} = 5\text{ V}, f = 20\text{ MHz}$	f_T	–	170	–	MHz
Output capacitance $V_{CB} = 10\text{ V}, f = 1\text{ MHz}$	C_{obo}	–	6	–	pF
Input capacitance $V_{EB} = 0.5\text{ V}, f = 1\text{ MHz}$	C_{ibo}	–	60	–	

¹⁾ Pulse test: $t \leq 300\text{ }\mu\text{s}, D \leq 2\%$.

Total power dissipation $P_{tot} = f(T_A^*; T_S)$

* Package mounted on epoxy

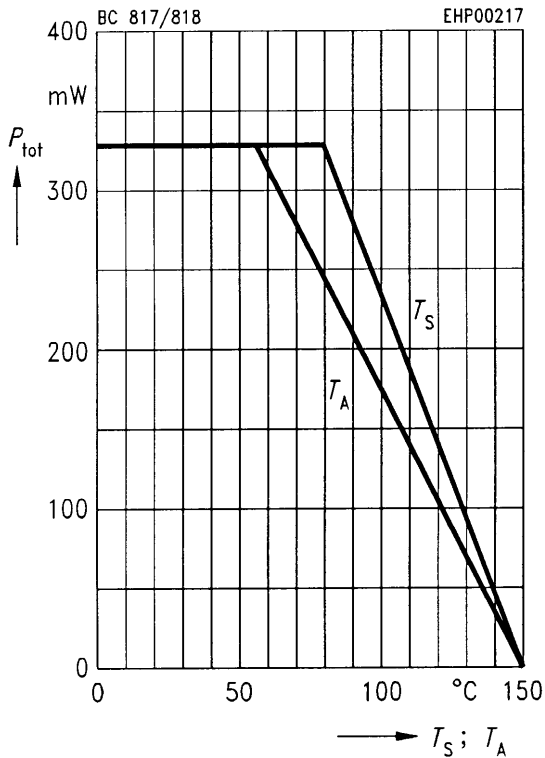

Transition frequency $f_T = f(I_C)$

$V_{CE} = 5 V$

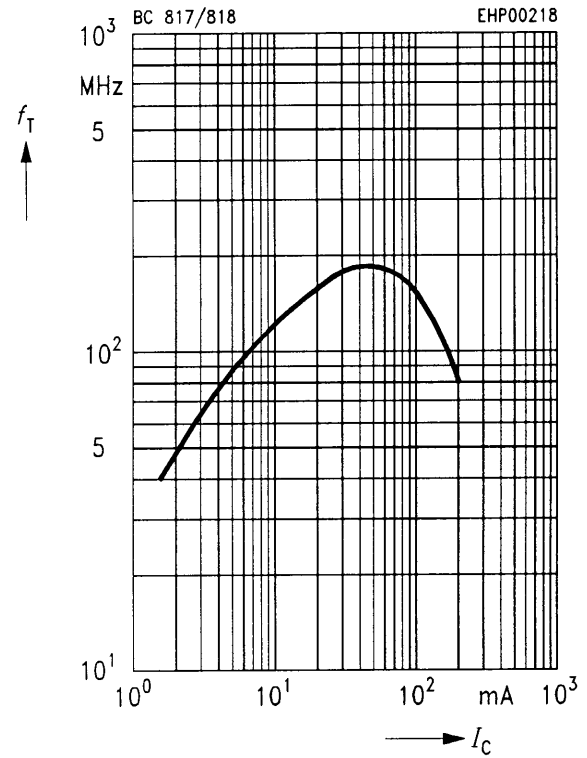

Permissible pulse load $P_{tot max}/P_{tot DC} = f(t_p)$

Collector cutoff current $I_{CBO} = f(T_A)$

$V_{CB0} = 60 V$

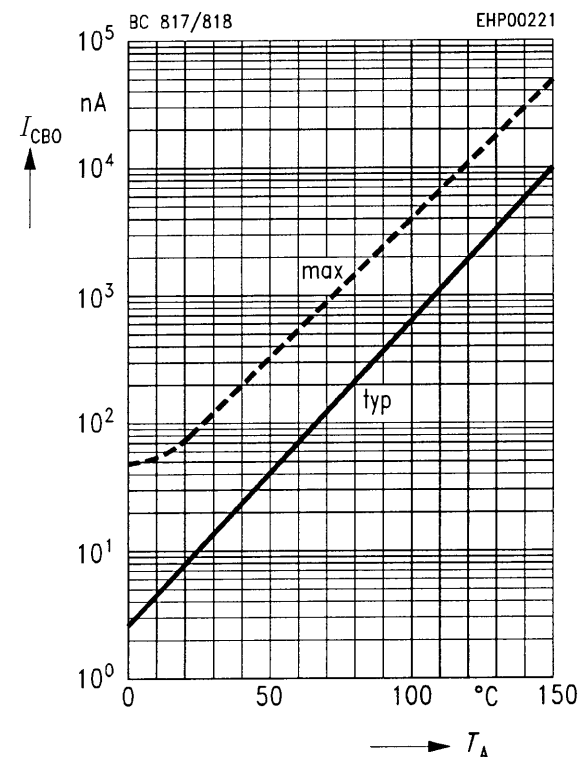
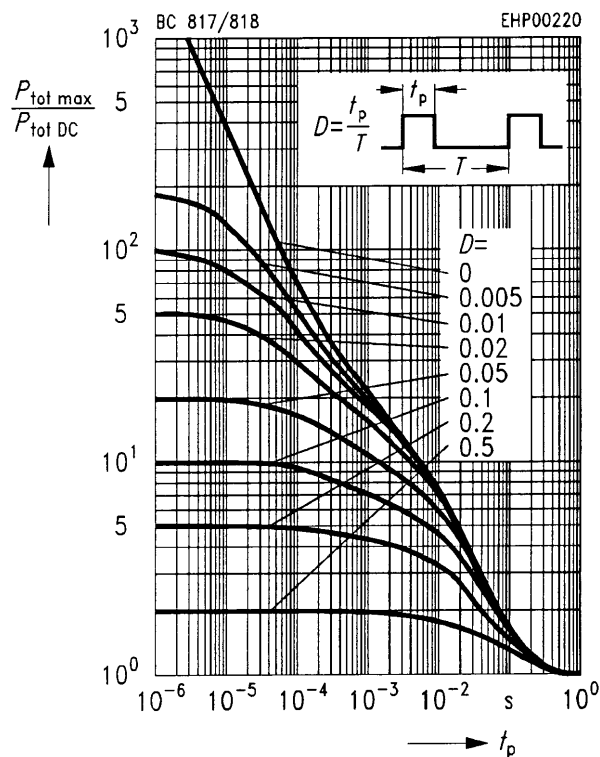

Base-emitter saturation voltage

$$I_C = f(V_{BEsat})$$

$$h_{FE} = 10$$

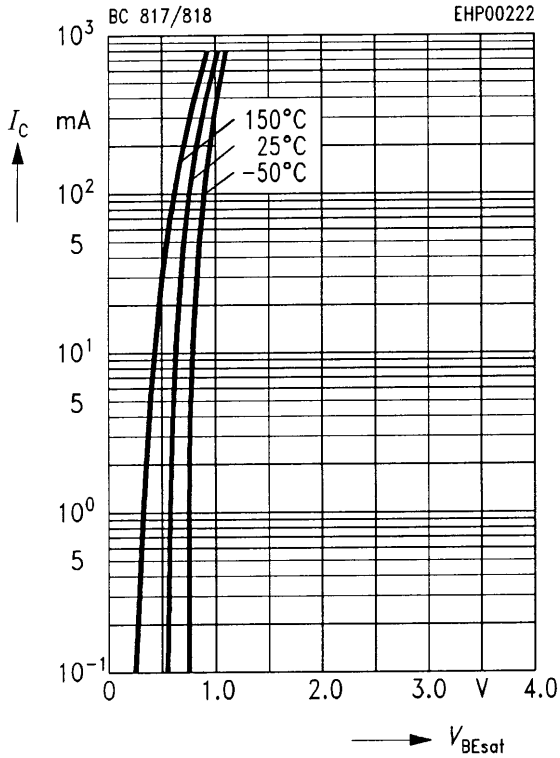

Collector-emitter saturation voltage

$$I_C = f(V_{CEsat})$$

$$h_{FE} = 10$$

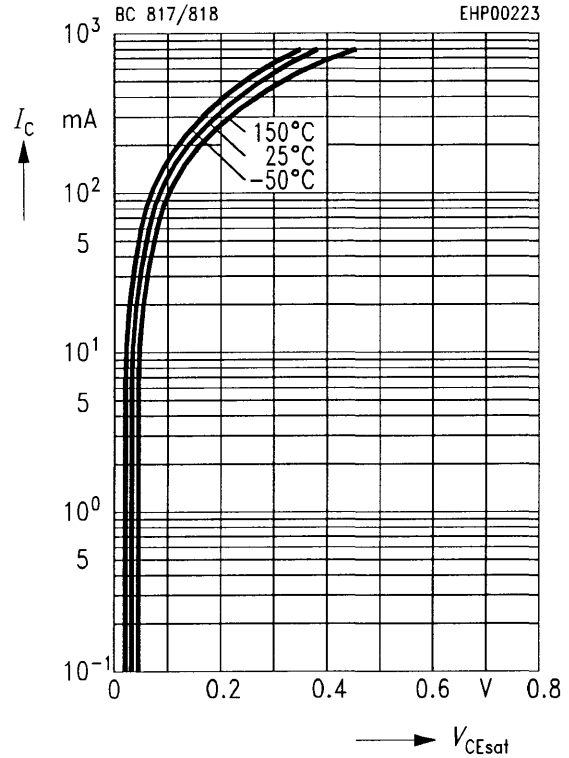

DC current gain $h_{FE} = f(I_C)$

$$V_{CE} = 1 \text{ V}$$

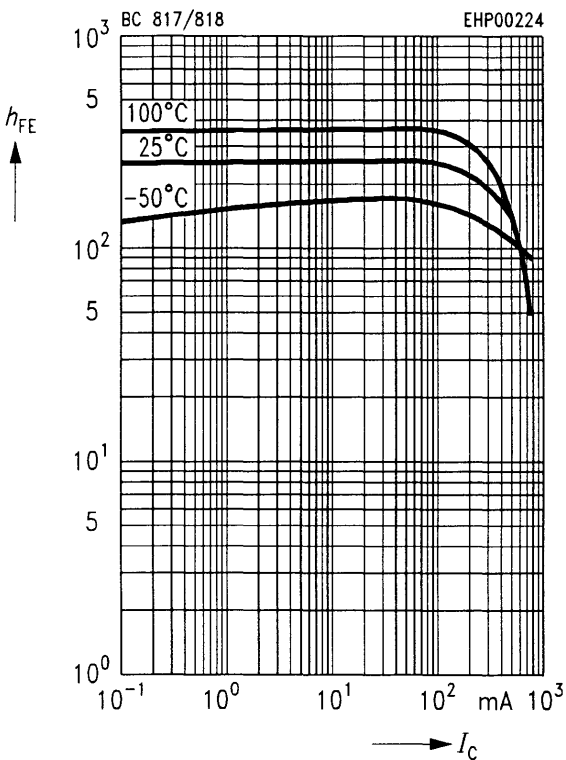

This datasheet has been download from:

www.datasheetcatalog.com

Datasheets for electronics components.